

FORESTRY

2022
EDITION



VTN[®]
A DIFFERENT WAY



APPLICATIONS



LEARN TO DIFFERENTIATE

PINZA TAGLIA TRONCHI

La Pinza Taglia Tronchi della serie W è l'attrezzatura ideale per le attività collegate alla silvicoltura e per la manutenzione di strade, linee ferroviarie, giardini, frutteti, aree ad elevata presenza di arbusti e alberi.

Utilizzabile su qualsiasi tipologia di escavatore assicura grande precisione e un'elevata qualità di taglio riducendo al minimo l'impatto sull'ambiente e sull'area di lavoro.

- > 3 modelli disponibili
- > Robusto gruppo di rotazione auto-frenante
- > Branchia di accumulo opzionale
- > Azionamento sequenziale integrato per presa e taglio
- > Facile movimentazione del materiale tagliato

HARVESTER SHEAR

The W Series range tree shears are the recommended tools for forest utility work, trimming limbs and trees for roadside, trails and railroad tracks maintenance, in hard-to-reach places as well as difficult slopes, steep cliffs or in fruit fields where cutting rates are more subject to tree spacing and operator skill.

- > 3 sizes available
- > Robust continuous 360° self-locking rotation
- > Optional additional clamp for accumulation of cut material
- > Gripping function with hydraulic manipulation and integrated cutting with interchangeable blade
- > Total grip-control of the cut material without falling parts during pruning

TÊTE D'ABATTAGE





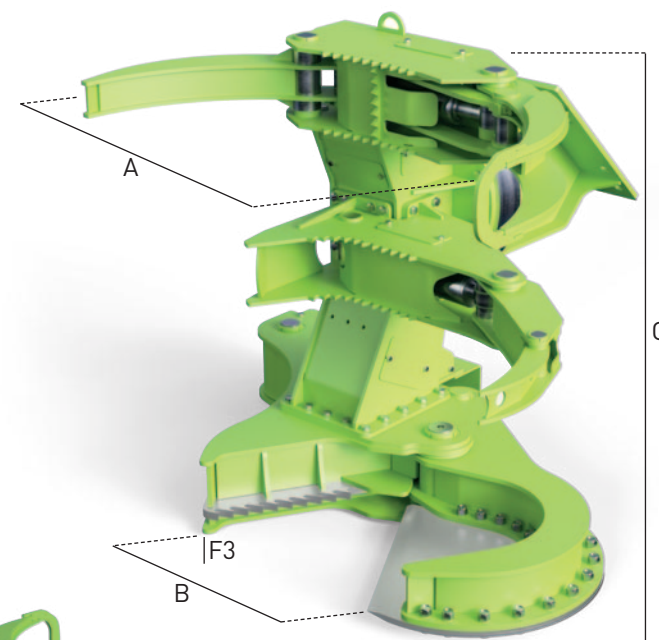

Les Sécateurs de la Série W sont des outils destinés au travaux forestiers ainsi que les coupes d'entretien.

Sa conception robuste permet de travailler dans des endroits parfois difficiles avec des bois très variables.

- > 3 tailles disponibles
- > Rotation auto-freinante continue à 360°
- > Collecteur supplémentaire en option pour l'accumulation des bois coupés
- > Fonction de préhension avec manipulation hydraulique. Coupe intégrée avec lame interchangeable
- > Contrôle total de la préhension du bois coupé limitant la chute des branches lors de l'élagage



	t min/max · lb min/max		
W800	8	10 / 15	17
	18000	22000 / 33000	38000
W1100	13	15 / 24	26
	29000	33000 / 53000	57000
W1600	23	25 / 35	35
	51000	55000 / 73000	77000

Model		W800	W1100	W1600
A	mm	1020	1410	1650
	in	40,2	55,5	65,0
B	mm	560	730	880
	in	22,0	28,7	34,6
C	mm	1115	1520	1640
	in	43,9	59,8	64,6
	mm	570	740	880
	in	22,4	29,1	34,6
soft wood diameter	mm	300	400	450
	in	11,8	15,7	17,7
hard wood diameter	mm	280	350	500
	in	11,0	13,8	19,7
F3	t	17	21	28
	Sh Ton	19	23	31
	°	360	360	360
	°	360	360	360
	l/min	30 / 40	30 / 40	30 / 40
	gal/min	7 / 10	7 / 10	7 / 10
	bar	175	175	175
	psi	2536	2536	2536
	l/min	70 / 80	80 / 100	110 / 140
	gal/min	18 / 21	21 / 26	29 / 36
	bar	250	250	280
	psi	3623	3623	4058
	kg	990	1650	2165
	lb	2200	3667	4811



TURN ON THE GREEN IN YOU

ESTRATTORE CEPPI

L'estrattore ceppi della serie SC è progettata per la raccolta e il recupero di biomassa da ceppaie.

Il suo particolare design consente sia lo sradicamento completo dal terreno che la riduzione del ceppo, favorendo così il successivo processo di trasporto, triturazione e cippatura.

È utilizzata per bonifiche di terreni, anche su larga scala e per la pulitura di appezzamenti destinati alla semina di nuove piantagioni.

- > 2 modelli disponibili
- > Doppia funzione, estrazione e riduzione del volume per ottimizzazione del trasporto
- > Design semplice e robusto

STUMP CUTTER

The SC series stump cutter is specially designed to extract the stump of a tree anchored to the ground from its roots.

It reduces the size of the stump it has been removed and it guarantees its correct reuse for the subsequent processing phases (chipping, shredding, biomass, etc.).

Suitable for any type of fitting size and variety of wood.

- > 2 sizes available
- > Double function for stump extraction and possible subsequent reduction before loading into the shredder
- > Simple and robust construction to ensure limited wear

CROQUE SOUCHE

Le croque-souche de la série SC est spécialement conçue pour enlever les souches d'un arbre ancré au sol par ses racines.



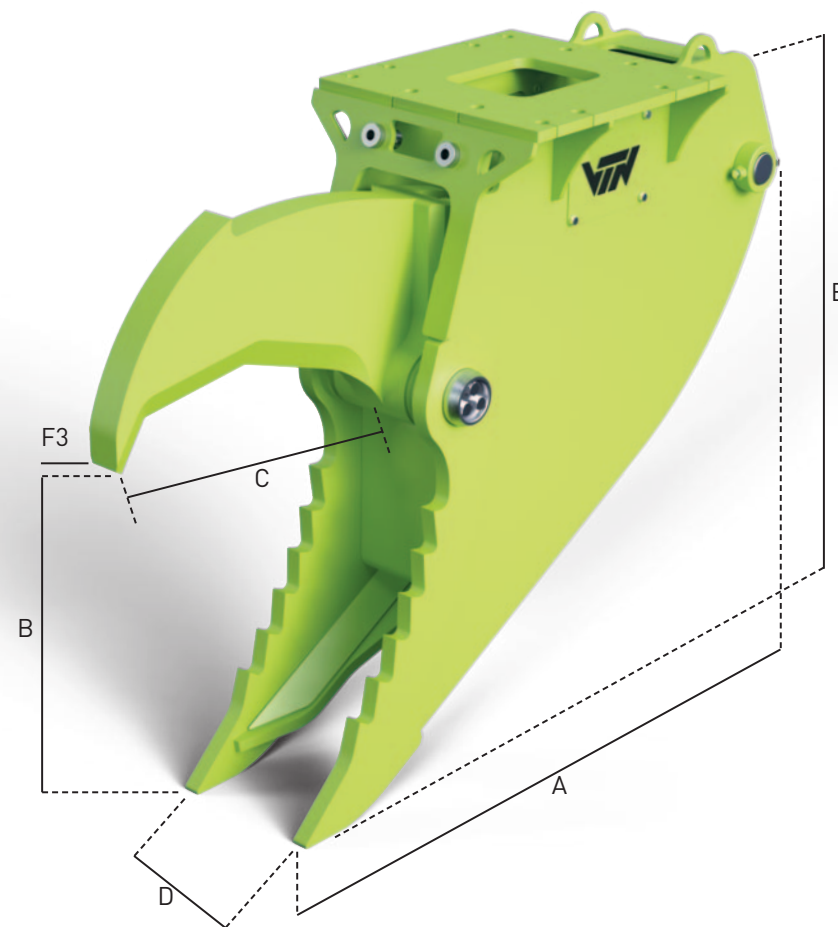

Il réduit la taille de la souche pour en garantir sa bonne réutilisation pour les phases de traitement ultérieures (déchetage, biomasse, etc.).

Ideal pour tous diamètres et variété de bois.

- > 2 tailles disponibles
- > Double fonction pour l'extraction de la souche et la réduction ultérieure possible avant le chargement dans le broyeur
- > Construction simple et robuste pour une usure réduite



FORESTRY

 t min/max · lb min/max			Model	SC12	SC21	
SC12	12	14 / 24	26	A	mm 2125	2500
	27000	31000 / 53000	57000		in 83,7	98,4
SC21	22	24 / 33	35	B	mm 1000	1400
	48000	53000 / 73000	77000		in 39,4	55,1
C					mm 740	950
					in 29,1	37,4
D					mm 390	480
					in 15,4	18,9
E					mm 1562	1910
					in 61,5	75,2
F3					t 28	42
					Sh Ton 31	46
					l/min 150 / 200	200 / 300
					gal/min 39 / 52	52 / 79
					bar 350	350
					psi 5072	5072
					kg 1210	2060
					lb 2689	4578



LOG IN LOG OUT

PINZA PER TRONCHI

La Pinza per tronchi della serie RV è progettata per aumentare la produttività della movimentazione del legname.

Utilizzata principalmente in aperta campagna o nei cantieri di legname, è disponibile per camion con gru, caricatori forestali, sollevatori telescopici, dove grandi quantità di tronchi e di legname possono essere movimentati e trasportati.

- > 5 modelli disponibili
- > Posizionamento preciso e sicuro di ramaglie e tronchi
- > Prestazioni di riempimento e bloccaggio ottimali
- > Disponibile con rotatore idraulico
- > Cicli di caricamento rapidi
- > Facilità di manutenzione e riparazione

LOG GRAB

The RV Series is designed to increase your timber handling productivity.

Mainly used in open country or on timber yards it is available for fixed mount use on excavator-based machines as well as for cranes, telescopic lifters, where large quantity of logs and round woods can be moved and transported.

- > 5 sizes available
- > Precise and safe placement of lumber and round woods
- > Optimum filling and clamping performance
- > Available with hydraulic rotator
- > Rapid loading cycles
- > Easy maintenance and repair

PINCES À BOIS

La série RV est conçue pour faciliter la manutention et le chargement du bois.

Principalement utilisé dans les champs ou sur les chantiers forestiers ainsi que les plateformes.

Les porteurs peuvent être les pelles, les grues ainsi que les téléchargeurs. Cette pince permet de charger ou d'empiler des grandes quantités de grumes ou branchage.

- > 5 tailles disponibles
- > Placement précis et possibilité de reprendre des troncs et des bois ronds
- > Remplissage et capacité de serrage optimales
- > Rotateur pour version en montage pendulaire
- > Cycles de chargement rapides
- > Maintenance et réparation facile

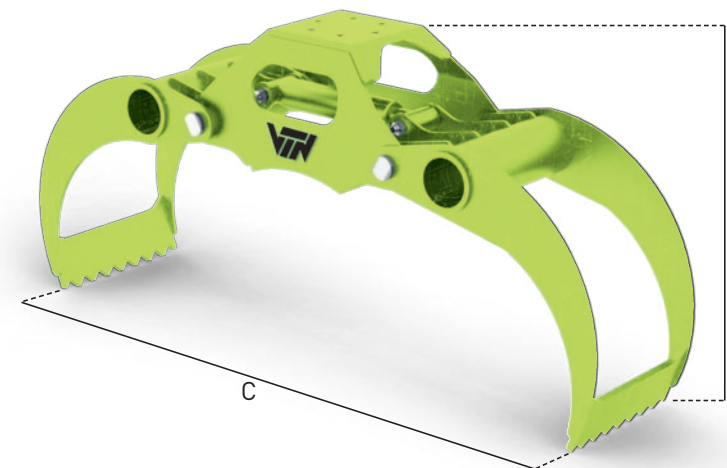

FORESTRY

	t min/max · lb min/max	
93RV91	2 / 5	4500 / 11000
93RV92	3 / 8	7000 / 18000
93RV94	7 / 10	16000 / 22000
93RV95	11 / 17	23000 / 38000
93RV96	18 / 25	39000 / 55000

Model		93RV91	93RV92	93RV94	93RV95	93RV96
Area	m ²	0,2	0,25	0,3	0,5	0,6
	ft ²	2,2	2,8	3,3	5,6	6,7
L	mm	330	380	550	630	920
	in	13,0	15,0	21,7	24,8	36,2
Lifting Capacity	t	1	1,5	2,5	3,5	4
	Sh Ton	1	1,6	2,7	3,8	4,4
A	mm	620	730	780	900	890
	in	24,4	28,7	30,7	35,4	35,0
B	mm	480	550	600	700	890
	in	18,9	21,7	23,6	27,6	35,0
C	mm	1080	1300	1540	1900	2160
	in	42,5	51,2	60,6	74,8	85,0
Ø	mm	95	125	155	165	230
	in	3,7	4,9	6,1	6,5	9,1
↻	°	360	360	360	360	360
	°	360	360	360	360	360
🔧	bar	200	200	200	200	280
	psi	2899	2899	2899	2899	4058
💧	l/min	20 / 30	20 / 30	20 / 30	20 / 30	80 / 90
	gal/min	5 / 7	5 / 7	5 / 7	5 / 7	21 / 23
👤	kg	95	120	235	400	800
	lb	211	267	522	889	1778
Rotator (Optional)	model	DTIA0401	DTIA0600	DTIA1200	DTIA1500	DTIA1200

VTN EUROPE S.p.A.

Via dell'Artigianato 41/43
36026 Cagnano di Pojana Maggiore · VI · Italy

T +39 0444.864.211

vtneurope.com

